

SECTION 9

ELECTRICAL PARTS LIST

Values are fixed unless marked Variable.

Ckt. No.	Tektronix Part No.	Serial/Model No. Eff Disc	Description
Bulbs			
B296	150-0035-00		Neon, A1D T2
B596	150-0035-00		Neon, A1D T2
B798	150-0035-00		Neon, A1D T2
B799	150-0035-00		Neon, A1D T2
Capacitors			
Tolerance $\pm 20\%$ unless otherwise indicated.			
C3	283-0079-00		0.01 μF Cer 250 V
C10	281-0613-00		10 pF Cer 200 V 10%
C14	283-0094-00		27 pF Cer 200 V 10%
C20	290-0134-00		22 μF Elect. 15 V
C25	283-0059-00		1 μF Cer 25 V +80% -20%
C26	283-0593-01		0.01 μF Mica 100 V 1%
C27	283-0593-01		0.01 μF Mica 100 V 1%
C35	283-0108-00		220 pF Cer 200 V 10%
C36	283-0084-00		270 pF Cer 1000 V 5%
C41	283-0076-00		27 pF Cer 500 V 10%
C44	283-0003-00		0.01 μF Cer 150 V
C50	281-0509-00		15 pF Cer 500 V 10%
C56	283-0054-00		150 pF Cer 200 V 5%
C70	283-0135-00		100 pF Cer
C72	283-0067-00		0.001 μF Cer 200 V 10%
C77	290-0134-00		22 μF Elect. 15 V
C78	283-0135-00		100 pF Cer
C79	283-0135-00		100 pF Cer
C109	283-0110-00		0.005 μF Cer 150 V
C112	283-0110-00		0.005 μF Cer 150 V
C113	283-0079-00		0.01 μF Cer 250 V
C115	283-0032-00		470 pF Cer 500 V 5%
C116	283-0065-00		0.001 μF Cer 100 V 5%
C120	283-0059-00		1 μF Cer 25 V +80% -20%
C128	283-0059-00		1 μF Cer 25 V +80% -20%
C130	281-0064-00		0.25-1.5 pF, Var Tub.
C131	281-0064-00		0.25-1.5 pF, Var Tub.
C132	283-0032-00		470 pF Cer 500 V 5%
C133	281-0043-00		0.7-3 pF, Var Tub.
C135	283-0069-00	B010100	15 pF Cer 50 V
C135	283-0166-00	B080000	15 pF Cer 50 V
C137	283-0067-00		0.001 μF Cer 200 V 10%

Electrical Parts List—Type 351

Capacitors (cont)

Ckt. No.	Tektronix Part No.	Serial/Model No. Eff	Disc		Description		
C138	283-0069-00	B010100	B079999	15 pF	Cer	50 V	
C138	283-0166-00	B080000		15 pF	Cer	50 V	5%
C142	281-0516-00			39 pF	Cer	500 V	10%
C147	283-0067-00			0.001 μ F	Cer	200 V	10%
C151	283-0067-00			0.001 μ F	Cer	200 V	10%
C152	283-0065-00			0.001 μ F	Cer	100 V	5%
C156	283-0059-00			1 μ F	Cer	25 V	+80%—20%
C160	283-0059-00			1 μ F	Cer	25 V	+80%—20%
C161	283-0026-00			0.2 μ F	Cer	25 V	
C162	283-0051-00			0.0033 μ F	Cer	100 V	5%
C172	283-0115-00			47 pF	Cer	200 V	5%
C176	283-0026-00			0.2 μ F	Cer	25 V	
C181	283-0067-00			0.001 μ F	Cer	200 V	10%
C190	281-0613-00			10 pF	Cer	200 V	10%
C194	281-0613-00			10 pF	Cer	200 V	10%
C202	283-0059-00			1 μ F	Cer	25 V	+80%—20%
C207	283-0004-00			0.02 μ F	Cer	150 V	
C209	281-0512-00	XB110000		27 pF	Cer	500 V	10%
C221	283-0026-00			0.2 μ F	Cer	25 V	
C230	283-0594-00			0.001 μ F	Mica	100 V	1%
C232	283-0059-00			1 μ F	Cer	25 V	+80%—20%
C241	283-0067-00	B010100	B099999X	0.001 μ F	Cer	200 V	10%
C243	283-0594-00	XB100000		0.001 μ F	Mica	100 V	1%
C247	283-0023-00	XB100000		0.1 μ F	Cer	10 V	
C253	281-0611-00	B010100	B099999	2.7 pF	Cer	200 V	± 0.25 pF
C253	283-0094-00	B100000		27 pF	Cer	200 V	10%
C261	283-0059-00			1 μ F	Cer	25 V	+80%—20%
C267	283-0059-00			1 μ F	Cer	25 V	+80%—20%
C272	283-0026-00			0.2 μ F	Cer	25 V	
C274	283-0026-00			0.2 μ F	Cer	25 V	
C276	285-0000-00			160 pF	Glass	500 V	1%
C295	283-0003-00			0.01 μ F	Cer	150 V	
C307	283-0144-00	XB090000		33 pF	Cer	500 V	1%
C415	283-0022-00			470 pF	Cer	500 V	5%
C416	283-0065-00			0.001 μ F	Cer	100 V	5%
C420	283-0059-00			1 μ F	Cer	25 V	+80%—20%
C428	283-0059-00			1 μ F	Cer	25 V	+80%—20%
C430	281-0064-00			0.25-1.5 pF, Var	Tub.		
C431	281-0064-00			0.25-1.5 pF, Var	Tub.		
C432	283-0032-00			470 pF	Cer	500 V	5%
C433	281-0043-00			0.7-3 pF, Var	Tub.		
C435	283-0069-00	B010100	B079999	15 pF	Cer	50 V	
C435	283-0166-00	B080000		15 pF	Cer	50 V	5%
C437	283-0067-00			0.001 μ F	Cer	200 V	10%
C438	283-0069-00	B010100	B079999	15 pF	Cer	50 V	
C438	283-0166-00	B080000		15 pF	Cer	50 V	5%
C442	281-0516-00			39 pF	Cer	500 V	10%
C447	283-0067-00			0.001 μ F	Cer	200 V	10%
C451	283-0067-00			0.001 μ F	Cer	200 V	10%
C452	283-0065-00			0.001 μ F	Cer	100 V	5%
C456	283-0059-00			1 μ F	Cer	25 V	+80%—20%
C460	283-0059-00			1 μ F	Cer	25 V	+80%—20%
C461	283-0026-00			0.2 μ F	Cer	25 V	
C462	283-0051-00			0.0033 μ F	Cer	100 V	5%

Capacitors (cont)

Ckt. No.	Tektronix Part No.	Serial/Model No. Eff	Disc	Description		
C472	283-0115-00			47 pF	Cer	200 V 5%
C476	283-0026-00			0.2 μ F	Cer	25 V
C481	283-0067-00			0.001 μ F	Cer	200 V 10%
C490	281-0613-00			10 pF	Cer	200 V 10%
C494	281-0613-00			10 pF	Cer	200 V 10%
C502	283-0059-00			1 μ F	Cer	25 V +80%—20%
C507	283-0004-00			0.02 μ F	Cer	150 V
C521	283-0026-00			0.2 μ F	Cer	25 V
C530	283-0594-00			0.001 μ F	Mica	100 V 1%
C532	283-0059-00			1 μ F	Cer	25 V +80%—20%
C541	283-0067-00	B010100	B09999X	0.001 μ F	Cer	200 V 10%
C543	283-0594-00	XB100000		0.001 μ F	Mica	100 V 1%
C547	283-0023-00	XB100000		0.1 μ F	Cer	10 V
C553	281-0611-00	B010100	B099999	2.7 pF	Cer	200 V ± 0.25 pF
C553	283-0094-00	B100000		27 pF	Cer	200 V 10%
C561	283-0059-00			1 μ F	Cer	25 V +80%—20%
C567	283-0059-00			1 μ F	Cer	25 V +80%—20%
C572	283-0026-00			0.2 μ F	Cer	25 V
C574	283-0026-00			0.2 μ F	Cer	25 V
C576	285-0000-00			160 pF	Glass	500 V 1%
C595	283-0003-00			0.01 μ F	Cer	150 V
C607	283-0144-00	XB090000		33 pF	Cer	500 V 1%
C702	283-0128-00			100 pF	Cer	500 V 5%
C713	283-0059-00			1 μ F	Cer	25 V +80%—20%
C719	283-0144-00			33 pF	Cer	500 V 1%
C723	283-0059-00			1 μ F	Cer	25 V +80%—20%
C729	283-0144-00			33 pF	Cer	500 V 1%
C779	281-0501-00			4.7 pF	Cer	500 V ± 1 pF
C782	283-0026-00			0.2 μ F	Cer	25 V
C816	283-0092-00			0.03 μ F	Cer	200 V +80%—20%
C822	290-0333-00			300 μ F	Elect.	25 V +75%—10%
C828	283-0076-00			27 pF	Cer	500 V 10%
C839	290-0167-00			10 μ F	Elect.	15 V
C853	283-0059-00			1 μ F	Cer	25 V +80%—20%
C855	283-0059-00	B010100	B039999X	1 μ F	Cer	25 V +80%—20%
C861	283-0059-00			1 μ F	Cer	25 V +80%—20%
C863	283-0059-00			1 μ F	Cer	25 V +80%—20%
C865	283-0059-00			1 μ F	Cer	25 V +80%—20%
C867	283-0059-00			1 μ F	Cer	25 V +80%—20%
C881	283-0067-00			0.001 μ F	Cer	200 V 10%
C882	283-0067-00			0.001 μ F	Cer	200 V 10%

Diodes

D1	152-0141-02	Silicon	1N4152
D31	*152-0185-00	Silicon	Replaceable by 1N4152
D37	*152-0185-00	Silicon	Replaceable by 1N4152
D41	*152-0233-00	Silicon	Tek Spec
D57	*152-0185-00	Silicon	Replaceable by 1N4152
D59	*152-0185-00	Silicon	Replaceable by 1N4152

Electrical Parts List—Type 351

Diodes (cont)

Ckt. No.	Tektronix Part No.	Serial/Model No. Eff	No. Disc	Description
D73	*152-0252-00			Snap-Off
D137A,B,C,D	*152-0314-00			Silicon
D139	152-0141-02			Silicon
D156	*152-0185-00			Silicon
D175	*152-0185-00			Silicon
				Pre-tested Tek Spec 1N4152 Replaceable by 1N4152 Replaceable by 1N4152
D200	*152-0185-00			Silicon
D202	*152-0185-00			Silicon
D210	*152-0185-00			Silicon
D214	*152-0185-00			Silicon
D216	*152-0185-00			Silicon
				Replaceable by 1N4152 Replaceable by 1N4152 Replaceable by 1N4152 Replaceable by 1N4152 Replaceable by 1N4152
D231	152-0195-00			Zener
D232	*152-0185-00			Silicon
D233	*152-0185-00			Silicon
D234	*152-0185-00			Silicon
D236	*152-0185-00			Silicon
				1N751A 0.4 W, 5.1 V, 5% Replaceable by 1N4152 Replaceable by 1N4152 Replaceable by 1N4152 Replaceable by 1N4152
D237	*152-0323-00			Silicon
D238	*152-0185-00			Silicon
D239	*152-0323-00			Silicon
D243	*152-0185-00			Silicon
D252	*152-0185-00	B010100	B099999X	Silicon
				Tek Spec Replaceable by 1N4152 Tek Spec Replaceable by 1N4152 Replaceable by 1N4152
D254	*152-0185-00			Silicon
D256	*152-0185-00			Silicon
D276	*152-0323-00			Silicon
D277	*152-0323-00			Silicon
D286	*152-0185-00			Silicon
				Replaceable by 1N4152 Replaceable by 1N4152 Tek Spec Tek made Replaceable by 1N4152
D306	*152-0185-00			Silicon
D310	*152-0185-00			Silicon
D316	*152-0185-00			Silicon
D317	152-0034-00	B010100	B069999	Zener
D317	152-0280-00	B070000		Zener
D331	*152-0185-00			Silicon
				Replaceable by 1N4152 Replaceable by 1N4152 Replaceable by 1N4152 1N753 0.4 W, 6.2 V, 5% 1N753A 0.4 W, 6.2 V, 5% Replaceable by 1N4152
D437A,B,C,D	*152-0314-00			Silicon
D439	152-0141-02			Silicon
D456	*152-0185-00			Silicon
D475	*152-0185-00			Silicon
D500	*152-0185-00			Silicon
				Tek Spec 1N4152 Replaceable by 1N4152 Replaceable by 1N4152 Replaceable by 1N4152
D502	*152-0185-00			Silicon
D510	*152-0185-00			Silicon
D514	*152-0185-00			Silicon
D516	*152-0185-00			Silicon
D531	152-0195-00			Zener
				Replaceable by 1N4152 Replaceable by 1N4152 Replaceable by 1N4152 Replaceable by 1N4152 1N751A 0.4 W, 5.1 V, 5%
D532	*152-0185-00			Silicon
D533	*152-0185-00			Silicon
D534	*152-0185-00			Silicon
D536	*152-0185-00			Silicon
D537	*152-0323-00			Silicon
				Replaceable by 1N4152 Replaceable by 1N4152 Replaceable by 1N4152 Replaceable by 1N4152 Tek Spec

Diodes (cont)

Ckt. No.	Tektronix Part No.	Serial/Model No. Eff	No. Disc		Description
D538	*152-0185-00			Silicon	Replaceable by 1N4152
D539	*152-0323-00			Silicon	Tek Spec
D543	*152-0185-00			Silicon	Replaceable by 1N4152
D552	*152-0185-00	B010100	B099999X	Silicon	Replaceable by 1N4152
D554	*152-0185-00			Silicon	Replaceable by 1N4152
D556	*152-0185-00			Silicon	Replaceable by 1N4152
D576	*152-0323-00			Silicon	Tek Spec
D577	*152-0323-00			Silicon	Tek Spec
D586	*152-0185-00			Silicon	Replaceable by 1N4152
D606	*152-0185-00			Silicon	Replaceable by 1N4152
D610	*152-0185-00			Silicon	Replaceable by 1N4152
D616	*152-0185-00			Silicon	Replaceable by 1N4152
D617	152-0034-00	B010100	B069999	Zener	1N753 0.4 W, 6.2 V, 10%
D617	152-0280-00	B070000		Zener	1N753A 0.4 W, 6.2 V, 5%
D701	*152-0233-00			Silicon	Tek Spec
D705	*152-0185-00			Silicon	Replaceable by 1N4152
D706	*152-0185-00			Silicon	Replaceable by 1N4152
D709	*152-0185-00			Silicon	Replaceable by 1N4152
D714	*152-0185-00			Silicon	Replaceable by 1N4152
D715	*152-0185-00			Silicon	Replaceable by 1N4152
D724	*152-0185-00			Silicon	Replaceable by 1N4152
D726	*152-0185-00			Silicon	Replaceable by 1N4152
D750	*152-0185-00			Silicon	Replaceable by 1N4152
D751	*152-0185-00			Silicon	Replaceable by 1N4152
D760	*152-0185-00			Silicon	Replaceable by 1N4152
D761	*152-0185-00			Silicon	Replaceable by 1N4152
D774	*152-0185-00			Silicon	Replaceable by 1N4152
D782	152-0165-00			Zener	1N753A 0.4 W, 6.2 V, 5%
D784	*152-0185-00			Silicon	Replaceable by 1N4152
D791	*152-0185-00			Silicon	Replaceable by 1N4152
D792	*152-0185-00			Silicon	Replaceable by 1N4152
D821 A,B,C,D (4)	*152-0107-00			Silicon	Replaceable by 1N647
D827	152-0195-00			Zener	1N751 0.4 W, 5.1 V, 5%
D829	*152-0185-00			Silicon	Replaceable by 1N4152
D891	*152-0107-00			Silicon	Replaceable by 1N647
D892	*152-0107-00			Silicon	Replaceable by 1N647
D894	*152-0107-00			Silicon	Replaceable by 1N647
D895	*152-0107-00			Silicon	Replaceable by 1N647
D897	*152-0107-00			Silicon	Replaceable by 1N647
D898	*152-0107-00			Silicon	Replaceable by 1N647

Connectors

J1	131-0391-00			Coax, 50 Ω male
P11	131-0149-00			24 contact, male
P12	131-0149-00			24 contact, male
J78	131-0391-00			Coax, 50 Ω male
J79	131-0391-00			Coax, 50 Ω male

Electrical Parts List—Type 351

Connectors (cont)

Ckt. No.	Tektronix Part No.	Serial/Model No. Eff	Disc	Description
J100	*132-0040-00			Adapter
J114	131-0391-00			Coax, 50 Ω male
J139	131-0391-00			Coax, 50 Ω male
J181	*136-0140-00			Socket, Banana Jack assembly
J299	*136-0140-00			Socket, Banana Jack assembly
J400	*132-0040-00			Adapter
J414	131-0391-00			Coax, 50 Ω male
J439	131-0391-00			Coax, 50 Ω male
J481	*136-0140-00			Socket, Banana Jack assembly
J599	*136-0140-00			Socket, Banana Jack assembly
J881	131-0206-00			Probe Power
J882	131-0206-00			Probe Power

Delay Line

DL101A,B	*119-0128-00			Delay Line Assembly
----------	--------------	--	--	---------------------

Inductors

L20	*120-0382-00			Toroid, 14 turns single
L24	*114-0179-00			500 μH - 800 μH, Var Core 276-0506-00
L71	*108-0057-01	B010100	B099999	8.8 μH
L71	*108-0057-00	B100000		8.8 μH
L77	*120-0382-00			Toroid, 14 turns single
L113	*120-0382-00			Toroid, 14 turns single
L298	*120-0402-00			Toroid, 3 turns single
L598	*120-0402-00			Toroid, 3 turns single
L751	276-0507-00	XB060000		Core, Ferramic Suppressor
L752	276-0507-00	XB060000		Core, Ferramic Suppressor
L753	276-0507-00	XB060000		Core, Ferramic Suppressor
L754	276-0507-00	XB060000		Core, Ferramic Suppressor
LR118 ¹	*308-0449-00			18 μH (1.5 kΩ)
LR119 ¹	*308-0448-00			1.2 μH (980 Ω)
LR418 ¹	*308-0449-00			18 μH (1.5 kΩ)
LR419 ¹	*308-0448-00			1.2 μH (980 Ω)

Transistors

Q7	151-0179-00			Silicon	2N3877A
Q11	*153-0556-00			Silicon	Selected 2N2501
Q31	151-0190-00			Silicon	2N3904
Q38	*151-0133-00			Silicon	Selected from 2N3251
Q54	151-0188-00			Silicon	2N3906
Q58	151-0188-00			Silicon	2N3906
Q76	*151-0087-00			Silicon	Replaceable by 2N1131
Q121	*151-0198-00			Silicon	Replaceable by MPS-918
Q151	151-1012-00			Silicon	FET
Q156	151-0188-00			Silicon	2N3906
Q158	151-0188-00			Silicon	2N3906
Q170	151-0188-00			Silicon	2N3906
Q173	*151-0192-00			Silicon	Replaceable by MPS-6521
Q201	151-0190-00			Silicon	2N3904
Q209	151-0190-00			Silicon	2N3904

¹Coil, resistor combination.

Transistors (cont)

Ckt. No.	Tektronix Part No.	Serial/Model No.		Material	Description
		Eff	Disc		
Q221	151-0190-00			Silicon	2N3904
Q228	151-0188-00			Silicon	2N3906
Q243	151-1007-00			Silicon	Dual FET
Q244	151-0261-00	XB100000		Silicon	Dual
Q252	151-0188-00			Silicon	2N3906
Q261	151-0190-00			Silicon	2N3904
Q266	151-0188-00			Silicon	2N3906
Q283	*151-0192-00			Silicon	Replaceable by MPS-6521
Q288	151-0188-00			Silicon	2N3906
Q307	151-0190-00			Silicon	2N3904
Q312	151-0188-00			Silicon	2N3906
Q421	*151-0198-00			Silicon	Replaceable by MPS-918
Q451	151-1012-00			Silicon	FET
Q456	151-0188-00			Silicon	2N3906
Q458	151-0188-00			Silicon	2N3906
Q470	151-0188-00			Silicon	2N3906
Q473	*151-0192-00			Silicon	Replaceable by MPS-6521
Q501	151-0190-00			Silicon	2N3904
Q509	151-0190-00			Silicon	2N3904
Q521	151-0190-00			Silicon	2N3904
Q528	151-0188-00			Silicon	2N3906
Q543	151-1007-00	XB100000		Silicon	Dual FET
Q544	151-0261-00			Silicon	Dual
Q552	151-0188-00			Silicon	2N3906
Q561	151-0190-00			Silicon	2N3904
Q566	151-0188-00			Silicon	2N3906
Q583	*151-0192-00			Silicon	Replaceable by MPS-6521
Q588	151-0188-00			Silicon	2N3906
Q607	151-0190-00			Silicon	2N3904
Q612	151-0188-00			Silicon	2N3906
Q714	151-0188-00			Silicon	2N3906
Q724	151-0188-00			Silicon	2N3906
Q749	151-0190-00			Silicon	2N3904
Q759	151-0190-00			Silicon	2N3904
Q771	*151-0150-01			Silicon	Selected from 2N3440
Q775	*151-0150-01			Silicon	Selected from 2N3440
Q781	*151-0150-01			Silicon	Selected from 2N3440
Q785	*151-0150-01			Silicon	Selected from 2N3440
Q793	151-0179-00			Silicon	2N3877A
Q795	151-0179-00			Silicon	2N3877A
Q815	151-0190-00			Silicon	2N3904
Q817	*151-0136-01			Silicon	Selected from 2N3053
Q825	151-0190-00			Silicon	2N3904
Q835	151-0190-00			Silicon	2N3904
Q839	*151-0148-00			Silicon	Selected from 40250 (RCA)

Electrical Parts List—Type 351

Resistors

Resistors are fixed, composition, $\pm 10\%$ unless otherwise indicated.

Ckt. No.	Tektronix Part No.	Serial/Model No. Eff	Disc	Description		
R1	317-0510-00		51 Ω	$\frac{1}{8}$ W		5%
R3	315-0101-00		100 Ω	$\frac{1}{4}$ W		5%
R5	311-0613-00		100 k Ω , Var			
R6	315-0563-00		56 k Ω	$\frac{1}{4}$ W		5%
R9	315-0302-00		3 k Ω	$\frac{1}{4}$ W		5%
R14	315-0123-00		12 k Ω	$\frac{1}{4}$ W		5%
R22	315-0103-00		10 k Ω	$\frac{1}{4}$ W		5%
R23	315-0512-00		5.1 k Ω	$\frac{1}{4}$ W		5%
R27	315-0102-00		1 k Ω	$\frac{1}{4}$ W		5%
R29	315-0331-00		330 Ω	$\frac{1}{4}$ W		5%
R31	315-0222-00		2.2 k Ω	$\frac{1}{4}$ W		5%
R33	315-0102-00		1 k Ω	$\frac{1}{4}$ W		5%
R35	315-0512-00		5.1 k Ω	$\frac{1}{4}$ W		5%
R37	315-0363-00		36 k Ω	$\frac{1}{4}$ W		5%
R40	301-0153-00		15 k Ω	$\frac{1}{2}$ W		5%
R43	301-0153-00		15 k Ω	$\frac{1}{2}$ W		5%
R44	315-0471-00		470 Ω	$\frac{1}{4}$ W		5%
R47	317-0122-00		1.2 k Ω	$\frac{1}{8}$ W		5%
R50	315-0333-00		33 k Ω	$\frac{1}{4}$ W		5%
R52	311-0607-00		10 k Ω , Var			
R53	315-0303-00		30 k Ω	$\frac{1}{4}$ W		5%
R55	315-0103-00		10 k Ω	$\frac{1}{4}$ W		5%
R57	315-0472-00		4.7 k Ω	$\frac{1}{4}$ W		5%
R59	315-0103-00		10 k Ω	$\frac{1}{4}$ W		5%
R64	315-0301-00		300 Ω	$\frac{1}{4}$ W		5%
R65	315-0301-00		300 Ω	$\frac{1}{4}$ W		5%
R72	317-0101-00		100 Ω	$\frac{1}{8}$ W		5%
R74	308-0218-00		150 Ω	3 W	WW	5%
R76	311-0607-00		10 k Ω , Var			
R100	307-0121-00		6.757 Ω	1/10 W		1%
R101	317-0271-00		270 Ω	$\frac{1}{8}$ W		5%
R103	317-0101-00		100 Ω	$\frac{1}{8}$ W		5%
R104	317-0101-00		100 Ω	$\frac{1}{8}$ W		5%
R106	317-0101-00		100 Ω	$\frac{1}{8}$ W		5%
R107	317-0101-00		100 Ω	$\frac{1}{8}$ W		5%
R109	317-0510-00		51 Ω	$\frac{1}{8}$ W		5%
R110	317-0101-00		100 Ω	$\frac{1}{8}$ W		5%
R111	317-0101-00		100 Ω	$\frac{1}{8}$ W		5%
R112	317-0510-00		51 Ω	$\frac{1}{8}$ W		5%
R115	317-0036-00		3.6 Ω	$\frac{1}{8}$ W		5%
R116	317-0082-00		8.2 Ω	$\frac{1}{8}$ W		5%
R118	321-0097-00		100 Ω	$\frac{1}{8}$ W	Prec	1%
R119	321-0109-00		133 Ω	$\frac{1}{8}$ W	Prec	1%
R120	315-0152-00		1.5 k Ω	$\frac{1}{4}$ W		5%
R121	307-0106-00		4.7 Ω	$\frac{1}{4}$ W		5%

Resistors (cont)

Ckt. No.	Tektronix Part No.	Serial/Model No. Eff	Disc	Description		
R122	315-0621-00		620 Ω	$\frac{1}{4}$ W		5%
R124	317-0100-00		10 Ω	$\frac{1}{8}$ W		5%
R125	321-0151-00		365 Ω	$\frac{1}{8}$ W	Prec	1%
R127	315-0510-00		51 Ω	$\frac{1}{4}$ W		5%
R128	315-0272-00		2.7 k Ω	$\frac{1}{4}$ W		5%
R131	315-0470-00		47 Ω	$\frac{1}{4}$ W		5%
R132	315-0361-00		360 Ω	$\frac{1}{4}$ W		5%
R134	317-0111-00		110 Ω	$\frac{1}{8}$ W		5%
R135	317-0242-00		2.4 k Ω	$\frac{1}{8}$ W		5%
R136	317-0201-00		200 Ω	$\frac{1}{8}$ W		5%
R137	317-0201-00		200 Ω	$\frac{1}{8}$ W		5%
R138	317-0242-00		2.4 k Ω	$\frac{1}{8}$ W		5%
R139	317-0181-00		180 Ω	$\frac{1}{8}$ W		5%
R140	317-0221-00		220 Ω	$\frac{1}{8}$ W		5%
R142	321-0381-00		90.9 k Ω	$\frac{1}{8}$ W	Prec	1%
R143	321-0441-00		383 k Ω	$\frac{1}{8}$ W	Prec	1%
R144	321-0318-00		20 k Ω	$\frac{1}{8}$ W	Prec	1%
R147	315-0752-00		7.5 k Ω	$\frac{1}{4}$ W		5%
R148	308-0429-00		22 k Ω	3 W	WW	1%
R150	308-0429-00		22 k Ω	3 W	WW	1%
R151	315-0512-00		5.1 k Ω	$\frac{1}{4}$ W		5%
R152	321-0097-00		100 Ω	$\frac{1}{8}$ W	Prec	1%
R154	321-0268-00		6.04 k Ω	$\frac{1}{8}$ W	Prec	1%
R155	317-0200-00		20 Ω	$\frac{1}{8}$ W		5%
R156	317-0101-00		100 Ω	$\frac{1}{8}$ W		5%
R157	315-0123-00		12 k Ω	$\frac{1}{4}$ W		5%
R158	321-0236-00		2.8 k Ω	$\frac{1}{8}$ W	Prec	1%
R159	317-0101-00		100 Ω	$\frac{1}{8}$ W		5%
R160	317-0101-00		100 Ω	$\frac{1}{8}$ W		5%
R163	315-0332-00		3.3 k Ω	$\frac{1}{4}$ W		5%
R164	315-0132-00		1.3 k Ω	$\frac{1}{4}$ W		5%
R165	311-0485-00		250 Ω , Var			
R167A	321-0661-00		600 Ω	$\frac{1}{8}$ W	Prec	1%
R167B	321-0126-00		200 Ω	$\frac{1}{8}$ W	Prec	1%
R167C	321-0097-00		100 Ω	$\frac{1}{8}$ W	Prec	1%
R167D	321-0657-00		60 Ω	$\frac{1}{8}$ W	Prec	1%
R167E	321-0030-00		20 Ω	$\frac{1}{8}$ W	Prec	1%
R167F	321-0001-00		10 Ω	$\frac{1}{8}$ W	Prec	1%
R168A	321-0660-00		417 Ω	$\frac{1}{8}$ W	Prec	1%
R168B	321-0659-00		139 Ω	$\frac{1}{8}$ W	Prec	1%
R168C	321-0658-00		69.4 Ω	$\frac{1}{8}$ W	Prec	1%
R168D	321-0656-00		21.3 Ω	$\frac{1}{8}$ W	Prec	1%
R168E	321-0655-00		10.3 Ω	$\frac{1}{8}$ W	Prec	1%
R168F	321-0654-00		10.1 Ω	$\frac{1}{8}$ W	Prec	1%
R169	321-0193-00		1 k Ω	$\frac{1}{8}$ W	Prec	1%
R173	315-0114-00		110 k Ω	$\frac{1}{4}$ W		5%
R175	308-0321-00		24.4 k Ω	5 W	WW	1%

Electrical Parts List—Type 351

Resistors (cont)

Ckt. No.	Tektronix Part No.	Serial/Model No. Eff	Disc	Description		
R177	315-0102-00			1 kΩ	1/4 W	5%
R178 ²	311-0529-00			25 kΩ, Var		
R179	315-0102-00			1 kΩ	1/4 W	5%
R181	321-0289-00			10 kΩ	1/8 W	Prec 1%
R183	321-0219-02			1.87 kΩ	1/8 W	Prec 0.5%
R185	321-0744-02			20.25 kΩ	1/8 W	Prec 0.5%
R186A	321-0746-02			162.6 kΩ	1/8 W	Prec 0.5%
R186B	321-1359-02			54.2 kΩ	1/8 W	Prec 0.5%
R186C	321-1330-02			27.1 kΩ	1/8 W	Prec 0.5%
R186D	321-0743-02			16.26 kΩ	1/8 W	Prec 0.5%
R186E	321-1263-02			5420 Ω	1/8 W	Prec 0.5%
R186F	321-1234-02			2710 Ω	1/8 W	Prec 0.5%
R187	321-0197-02			1.1 kΩ	1/8 W	Prec 0.5%
R188	321-0742-02			11.84 kΩ	1/8 W	Prec 0.5%
R190	321-0441-00			383 kΩ	1/8 W	Prec 1%
R191	315-0153-00			15 kΩ	1/4 W	5%
R192	311-0510-00			10 kΩ, Var		
R193	315-0153-00			15 kΩ	1/4 W	5%
R194	321-0441-00			383 kΩ	1/8 W	Prec 1%
R196	315-0512-00			5.1 kΩ	1/4 W	5%
R197	315-0153-00			15 kΩ	1/4 W	5%
R198	311-0614-00			30 kΩ, Var		
R199	315-0512-00			5.1 kΩ	1/4 W	5%
R201	301-0563-00			56 kΩ	1/2 W	5%
R202	315-0272-00			2.7 kΩ	1/4 W	5%
R204	321-0411-00			187 kΩ	1/8 W	Prec 1%
R206	315-0203-00	B010100	B099999	20 kΩ	1/4 W	5%
R206	315-0303-00	B100000		30 kΩ	1/4 W	5%
R207	315-0912-00			9.1 kΩ	1/4 W	5%
R209	315-0101-00			100 Ω	1/4 W	5%
R210	315-0101-00			100 Ω	1/4 W	5%
R212	311-0614-00			30 kΩ, Var		
R213	315-0912-00			9.1 kΩ	1/4 W	5%
R215	315-0131-00			130 Ω	1/4 W	5%
R217	315-0104-00			100 kΩ	1/4 W	5%
R221	315-0101-00			100 Ω	1/4 W	5%
R223	315-0510-00			51 Ω	1/4 W	5%
R225	315-0510-00			51 Ω	1/4 W	5%
R228	315-0101-00			100 Ω	1/4 W	5%
R231	321-0242-00	B010100	B099999	3.24 kΩ	1/8 W	Prec 1%
R231	321-0235-00	B100000		2.74 kΩ	1/8 W	Prec 1%
R232	321-0231-00			2.49 kΩ	1/8 W	Prec 1%
R233	321-0231-00			2.49 kΩ	1/8 W	Prec 1%
R234	321-0242-00	B010100	B099999	3.24 kΩ	1/8 W	Prec 1%
R234	321-0235-00	B100000		2.74 kΩ	1/8 W	Prec 1%
R236	317-0242-00			2.4 kΩ	1/8 W	5%
R238	317-0242-00			2.4 kΩ	1/8 W	5%
R241	315-0102-00	B010100	B099999X	1 kΩ	1/4 W	5%

²Furnished as a unit with R323.

Resistors (cont)

Ckt. No.	Tektronix Part No.	Serial/Model No. Eff	Disc		Description		
R243	301-0513-00			51 kΩ	1/2 W		5%
R244	322-1389-01	B010100	B099999X	111 kΩ	1/4 W	Prec	0.5%
R245	321-0296-00	B010100	B099999	11.8 kΩ	1/8 W	Prec	1%
R245	315-0432-00	B100000		4.3 kΩ	1/4 W		5%
R246	315-0471-00	B010100	B099999X	470 Ω	1/4 W		5%
R247	311-0635-00			1 kΩ, Var			
R248	315-0471-00	B010100	B099999X	470 Ω	1/4 W		5%
R249	321-0296-00	B010100	B099999	11.8 kΩ	1/8 W	Prec	1%
R249	315-0432-00	B100000		4.3 kΩ	1/4 W		5%
R251	315-0101-00			100 Ω	1/4 W		5%
R253	315-0102-00	B010100	B099999	1 kΩ	1/4 W		5%
R253	315-0390-00	B100000		39 Ω	1/4 W		5%
R255	315-0241-00			240 Ω	1/4 W		5%
R257	301-0513-00			51 kΩ	1/2 W		5%
R259	315-0241-00			240 Ω	1/4 W		5%
R260	315-0106-00	XB100000		10 MΩ	1/4 W		5%
R261	315-0101-00			100 Ω	1/4 W		5%
R263	317-0101-00			100 Ω	1/8 W		5%
R265	317-0101-00			100 Ω	1/8 W		5%
R267	317-0101-00			100 Ω	1/8 W		5%
R271	322-1389-01			111 kΩ	1/4 W	Prec	0.5%
R272	321-0283-00			8.66 kΩ	1/8 W	Prec	1%
R274	321-0292-00			10.7 kΩ	1/8 W	Prec	1%
R275	322-1389-01			111 kΩ	1/4 W	Prec	0.5%
R280	321-0677-00			30.4 kΩ	1/8 W	Prec	0.5%
R281	321-0387-00			105 kΩ	1/8 W	Prec	1%
R282	307-0006-00			68 kΩ	1/8 W		
R283	311-0607-00			10 kΩ, Var			
R284	315-0124-00			120 kΩ	1/4 W		5%
R286	315-0101-00			100 Ω	1/4 W		5%
R287	308-0320-00			15.6 kΩ	3 W	WW	1%
R288	321-0677-00			30.4 kΩ	1/8 W	Prec	0.5%
R289	315-0101-00			100 Ω	1/4 W		5%
R293 ³	*311-0659-00			10 kΩ, Var			
R295	315-0102-00			1 kΩ	1/4 W		5%
R296	315-0204-00			200 kΩ	1/4 W		5%
R298	321-0745-03			25.05 kΩ	1/8 W	Prec	0.25%
R299	321-1310-03			16.7 kΩ	1/8 W	Prec	0.25%
R301	311-0609-00			2 kΩ, Var			
R303	315-0132-00			1.3 kΩ	1/4 W		5%
R304	321-0617-00			111 kΩ	1/8 W	Prec	1%
R305	315-0681-00			680 Ω	1/4 W		5%
R307	315-0124-00			120 kΩ	1/4 W		5%
R312	308-0320-00			15.6 kΩ	3 W	WW	1%
R315	315-0101-00			100 Ω	1/4 W		5%
R318	321-0309-00			16.2 kΩ	1/8 W	Prec	1%
R321	321-0309-00			16.2 kΩ	1/8 W	Prec	1%
R323 ⁴	311-0529-00			2.5 kΩ, Var			
R332	315-0203-00			20 kΩ	1/4 W		5%
R334	315-0204-00			200 kΩ	1/4 W		5%

³Furnished as a unit with SW293A,B.⁴Furnished as a unit with R178.

Electrical Parts List—Type 351

Resistors (cont)

Ckt. No.	Tektronix Part No.	Serial/Model No. Eff	Disc	Description		
R400	307-0121-00		6.757 Ω	1/10 W		1%
R401	317-0271-00		270 Ω	1/8 W		5%
R415	317-0036-00		3.6 Ω	1/8 W		5%
R416	317-0082-00		8.2 Ω	1/8 W		5%
R418	321-0097-00		100 Ω	1/8 W	Prec	1%
R419	321-0109-00		133 Ω	1/8 W	Prec	1%
R420	315-0152-00		1.5 k Ω	1/4 W		5%
R421	307-0106-00		4.7 Ω	1/4 W		5%
R422	315-0621-00		620 Ω	1/4 W		5%
R424	317-0100-00		10 Ω	1/8 W		5%
R425	321-0151-00		365 Ω	1/8 W	Prec	1%
R427	315-0510-00		51 Ω	1/4 W		5%
R428	315-0272-00		2.7 k Ω	1/4 W		5%
R431	315-0470-00		47 Ω	1/4 W		5%
R432	315-0361-00		360 Ω	1/4 W		5%
R434	317-0111-00		110 Ω	1/8 W		5%
R435	317-0242-00		2.4 k Ω	1/8 W		5%
R436	317-0201-00		200 Ω	1/8 W		5%
R437	317-0201-00		200 Ω	1/8 W		5%
R438	317-0242-00		2.4 k Ω	1/8 W		5%
R439	317-0181-00		180 Ω	1/8 W		5%
R440	317-0221-00		220 Ω	1/8 W		5%
R442	321-0381-00		90.9 k Ω	1/8 W	Prec	1%
R443	321-0441-00		383 k Ω	1/8 W	Prec	1%
R444	321-0318-00		20 k Ω	1/8 W	Prec	1%
R447	315-0752-00		7.5 k Ω	1/4 W		5%
R448	308-0429-00		22 k Ω	3 W	WW	1%
R450	308-0429-00		22 k Ω	3 W	WW	1%
R451	315-0512-00		5.1 k Ω	1/4 W		5%
R452	321-0097-00		100 Ω	1/8 W	Prec	1%
R454	321-0268-00		6.04 k Ω	1/8 W	Prec	1%
R455	317-0200-00		20 Ω	1/8 W		5%
R456	317-0101-00		100 Ω	1/8 W		5%
R457	315-0123-00		12 k Ω	1/4 W		5%
R458	321-0236-00		2.8 k Ω	1/8 W	Prec	1%
R459	317-0101-00		100 Ω	1/8 W		5%
R460	317-0101-00		100 Ω	1/8 W		5%
R463	315-0332-00		3.3 k Ω	1/4 W		5%
R464	315-0132-00		1.3 k Ω	1/4 W		5%
R465	311-0485-00		250 Ω , Var			
R467A	321-0661-00		600 Ω	1/8 W	Prec	1%
R467B	321-0126-00		200 Ω	1/8 W	Prec	1%
R467C	321-0097-00		100 Ω	1/8 W	Prec	1%
R467D	321-0657-00		60 Ω	1/8 W	Prec	1%
R467E	321-0030-00		20 Ω	1/8 W	Prec	1%
R467F	321-0001-00		10 Ω	1/8 W	Prec	1%
R468A	321-0660-00		417 Ω	1/8 W	Prec	1%

Resistors (cont)

Ckt. No.	Tektronix Part No.	Serial/Model No. Eff	Disc	Description		
R468B	321-0659-00			139 Ω	$\frac{1}{8}$ W	Prec 1%
R468C	321-0658-00			69.4 Ω	$\frac{1}{8}$ W	Prec 1%
R468D	321-0656-00			21.3 Ω	$\frac{1}{8}$ W	Prec 1%
R468E	321-0655-00			10.3 Ω	$\frac{1}{8}$ W	Prec 1%
R468F	321-0654-00			10.1 Ω	$\frac{1}{8}$ W	Prec 1%
R469	321-0193-00			1 k Ω	$\frac{1}{8}$ W	Prec 1%
R473	315-0114-00			110 k Ω	$\frac{1}{4}$ W	5%
R475	308-0321-00			24.4 k Ω	5 W	WW 1%
R477	315-0102-00			1 k Ω	$\frac{1}{4}$ W	5%
R478*	311-0529-00			25 k Ω , Var		
R479	315-0102-00			1 k Ω	$\frac{1}{4}$ W	5%
R481	321-0289-00			10 k Ω	$\frac{1}{8}$ W	Prec 1%
R483	321-0219-02			1.87 k Ω	$\frac{1}{8}$ W	Prec 0.5%
R485	321-0744-02			20.25 k Ω	$\frac{1}{8}$ W	Prec 0.5%
R486A	321-0746-02			162.6 k Ω	$\frac{1}{8}$ W	Prec 0.5%
R486B	321-1359-02			54.2 k Ω	$\frac{1}{8}$ W	Prec 0.5%
R486C	321-1330-02			27.1 k Ω	$\frac{1}{8}$ W	Prec 0.5%
R486D	321-0743-02			16.26 k Ω	$\frac{1}{8}$ W	Prec 0.5%
R486E	321-1263-02			5420 Ω	$\frac{1}{8}$ W	Prec 0.5%
R486F	321-1234-02			2710 Ω	$\frac{1}{8}$ W	Prec 0.5%
R487	321-0197-02			1.1 k Ω	$\frac{1}{8}$ W	Prec 0.5%
R488	321-0742-02			11.84 k Ω	$\frac{1}{8}$ W	Prec 0.5%
R490	321-0441-00			383 k Ω	$\frac{1}{8}$ W	Prec 1%
R491	315-0153-00			15 k Ω	$\frac{1}{4}$ W	5%
R492	311-0510-00			10 k Ω , Var		
R493	315-0153-00			15 k Ω	$\frac{1}{4}$ W	5%
R494	321-0441-00			383 k Ω	$\frac{1}{8}$ W	Prec 1%
R496	315-0512-00			5.1 k Ω	$\frac{1}{4}$ W	5%
R497	315-0153-00			15 k Ω	$\frac{1}{4}$ W	5%
R498	311-0614-00			30 k Ω , Var		
R499	315-0512-00			5.1 k Ω	$\frac{1}{4}$ W	5%
R501	301-0563-00			56 k Ω	$\frac{1}{2}$ W	5%
R502	315-0272-00			2.7 k Ω	$\frac{1}{4}$ W	5%
R504	321-0411-00			187 k Ω	$\frac{1}{8}$ W	Prec 1%
R506	315-0203-00	B010100	B099999	20 k Ω	$\frac{1}{4}$ W	5%
R506	315-0303-00	B100000		30 k Ω	$\frac{1}{4}$ W	5%
R507	315-0912-00			9.1 k Ω	$\frac{1}{4}$ W	5%
R509	315-0101-00			100 Ω	$\frac{1}{4}$ W	5%
R510	315-0101-00			100 Ω	$\frac{1}{4}$ W	5%
R512	311-0614-00			30 k Ω , Var		
R513	315-0912-00			9.1 k Ω	$\frac{1}{4}$ W	5%
*R515	315-0131-00			130 Ω	$\frac{1}{4}$ W	5%
R517	315-0104-00			100 k Ω	$\frac{1}{4}$ W	5%
R521	315-0101-00			100 Ω	$\frac{1}{4}$ W	5%
R523	315-0510-00			51 Ω	$\frac{1}{4}$ W	5%
R525	315-0510-00			51 Ω	$\frac{1}{4}$ W	5%

*Furnished as a unit with R623.

Electrical Parts List—Type 351

Resistors (cont)

Ckt. No.	Tektronix Part No.	Serial/Model No. Eff	Disc		Description		
R528	315-0101-00			100 Ω	1/4 W		5%
R531	321-0242-00	B010100	B099999	3.24 kΩ	1/8 W	Prec	1%
R531	321-0235-00	B100000		2.74 kΩ	1/8 W	Prec	1%
R532	321-0231-00			2.49 kΩ	1/8 W	Prec	1%
R533	321-0231-00			2.49 kΩ	1/8 W	Prec	1%
R534	321-0242-00	B010100	B099999	3.24 kΩ	1/8 W	Prec	1%
R534	321-0235-00	B100000		2.74 kΩ	1/8 W	Prec	1%
R536	317-0242-00			2.4 kΩ	1/8 W		5%
R538	317-0242-00			2.4 kΩ	1/8 W		5%
R541	315-0102-00	B010100	B099999X	1 kΩ	1/4 W		5%
R543	301-0513-00			51 kΩ	1/2 W		5%
R544	322-1389-01	B010100	B099999X	11.1 kΩ	1/4 W	Prec	0.5%
R545	321-0296-00	B010100	B099999	11.8 kΩ	1/8 W	Prec	1%
R545	315-0432-00	B100000		4.3 kΩ	1/4 W		5%
R546	315-0471-00	B010100	B099999X	470 Ω	1/4 W		5%
R547	311-0635-00			1 kΩ, Var			
R548	315-0471-00	B010100	B099999X	470 Ω	1/4 W		5%
R549	321-0296-00	B010100	B099999	11.8 kΩ	1/8 W	Prec	1%
R549	315-0432-00	B100000		4.3 kΩ	1/4 W		5%
R551	315-0101-00			100 Ω	1/4 W		5%
R553	315-0102-00	B010100	B099999	1 kΩ	1/4 W		5%
R553	315-0390-00	B100000		39 Ω	1/4 W		5%
R555	315-0241-00			240 Ω	1/4 W		5%
R557	301-0513-00			51 kΩ	1/2 W		5%
R559	315-0241-00			240 Ω	1/4 W		5%
R560	315-0106-00	XB100000		10 MΩ	1/4 W		5%
R561	315-0101-00			100 Ω	1/4 W		5%
R563	317-0101-00			100 Ω	1/8 W		5%
R565	317-0101-00			100 Ω	1/8 W		5%
R567	317-0101-00			100 Ω	1/8 W		5%
R571	322-1389-01			111 kΩ	1/4 W	Prec	0.5%
R572	321-0283-00			8.66 kΩ	1/8 W	Prec	1%
R574	321-0292-00			10.7 kΩ	1/8 W	Prec	1%
R575	322-1389-01			111 kΩ	1/4 W	Prec	0.5%
R580	321-0677-00			30.4 kΩ	1/8 W	Prec	0.5%
R581	321-0387-00			105 kΩ	1/8 W	Prec	1%
R582	307-0006-00			68 kΩ	1/8 W		
R583	311-0607-00			10 kΩ, Var			
R584	315-0124-00			120 kΩ	1/4 W		5%
R586	315-0101-00			100 Ω	1/4 W		5%
R587	308-0320-00			15.6 kΩ	3 W	WW	1%
R588	321-0677-00			30.4 kΩ	1/8 W	Prec	0.5%
R589	315-0101-00			100 Ω	1/4 W		5%
R593 ^a	*311-0659-00			10 kΩ, Var			
R595	315-0102-00			1 kΩ	1/4 W		5%
R596	315-0204-00			200 kΩ	1/4 W		5%
R598	321-0745-03			25.05 kΩ	1/8 W	Prec	0.25%
R599	321-1310-03			16.7 kΩ	1/8 W	Prec	0.25%
R601	311-0609-00			2 kΩ, Var			
R603	315-0132-00			1.3 kΩ	1/4 W		5%
R604	321-0617-00			111 kΩ	1/8 W	Prec	1%
R605	315-0681-00			680 Ω	1/4 W		5%

^aFurnished as a unit with SW593A,B .

Resistors (cont)

Ckt. No.	Tektronix Part No.	Serial/Model No. Eff	Disc	Description		
R607	315-0124-00		120 k Ω	1/4 W		5%
R612	308-0320-00		15.6 k Ω	3 W	WW	1%
R615	315-0101-00		100 Ω	1/4 W		5%
R618	321-0309-00		16.2 k Ω	1/8 W	Prec	1%
R621	321-0309-00		16.2 k Ω	1/8 W	Prec	1%
R623 ⁷	311-0529-00		2.5 k Ω , Var			
R641	321-1289-01		10.1 k Ω	1/8 W	Prec	0.5%
R701	315-0203-00		20 k Ω	1/4 W		5%
R703	315-0100-00		10 Ω	1/4 W		5%
R707	315-0222-00		2.2 k Ω	1/4 W		5%
R708	315-0223-00		22 k Ω	1/4 W		5%
R709	315-0103-00		10 k Ω	1/4 W		5%
R711	315-0101-00		100 Ω	1/4 W		5%
R713	315-0101-00		100 Ω	1/4 W		5%
R715	315-0562-00		5.6 k Ω	1/4 W		5%
R718	315-0105-00		1 M Ω	1/4 W		5%
R719	315-0363-00		36 k Ω	1/4 W		5%
R723	315-0101-00		100 Ω	1/4 W		5%
R725	315-0562-00		5.6 k Ω	1/4 W		5%
R728	315-0105-00		1 M Ω	1/4 W		5%
R729	315-0363-00		36 k Ω	1/4 W		5%
R748	321-0295-00		11.5 k Ω	1/8 W	Prec	1%
R749	321-0250-00		3.92 k Ω	1/8 W	Prec	1%
R753	321-0238-00		2.94 k Ω	1/8 W	Prec	1%
R756	311-0635-00		1 k Ω , Var			
R758	321-0293-00		11 k Ω	1/8 W	Prec	1%
R759	321-0250-00		3.92 k Ω	1/8 W	Prec	1%
R762	321-0231-00		2.49 k Ω	1/8 W	Prec	1%
R764	311-0091-00		1 k Ω , Var			
R766	311-0607-00		10 k Ω , Va			
R767	315-0333-00		33 k Ω	1/4 W		5%
R769	315-0223-00		22 k Ω	1/4 W		5%
R771	301-0303-00		30 k Ω	1/2 W		5%
R772	301-0303-00		30 k Ω	1/2 W		5%
R777	323-0405-00		162 k Ω	1/2 W	Prec	1%
R779	301-0164-00		160 k Ω	1/2 W		5%
R780	321-0284-00		8.87 k Ω	1/8 W	Prec	1%
R781	301-0303-00		30 k Ω	1/2 W		5%
R782	301-0303-00		30 k Ω	1/2 W		5%
R787	301-0164-00		160 k Ω	1/2 W		5%
R789	301-0164-00		160 k Ω	1/2 W		5%
R791	315-0304-00		300 k Ω	1/4 W		5%
R793	315-0304-00		300 k Ω	1/4 W		5%
R795	315-0624-00		620 k Ω	1/4 W		5%
R797	315-0106-00		10 M Ω	1/4 W		5%

⁷Furnished as a unit with R478.

Electrical Parts List—Type 351

Resistors (cont)

Ckt. No.	Tektronix Part No.	Serial/Model No. Eff	No. Disc	Description		
R801	301-0473-00			47 k Ω	1/2 W	5%
R803	315-0102-00			1 k Ω	1/4 W	5%
R813	321-0311-00			16.9 k Ω	1/8 W	Prec 1%
R814	322-0367-00			64.9 k Ω	1/4 W	Prec 1%
R815	315-0102-00			1 k Ω	1/4 W	5%
R817	308-0299-00			300 Ω	3 W	WW 1%
R825	315-0114-00			110 k Ω	1/4 W	5%
R827	315-0182-00			1.8 k Ω	1/4 W	5%
R829	315-0124-00			120 k Ω	1/4 W	5%
R831	321-0193-00			1 k Ω	1/8 W	Prec 1%
R832	311-0605-00			200 Ω , Var		
R833	321-0172-00			604 Ω	1/8 W	Prec 1%
R835	315-0123-00			12 k Ω	1/4 W	5%
R841	308-0293-00	B010100	B029999X	4 k Ω	3 W	WW 5%
R843	308-0293-00			4 k Ω	3 W	WW 5%
R851	315-0101-00			100 Ω	1/4 W	5%
R853	315-0101-00			100 Ω	1/4 W	5%
R861	315-0101-00			100 Ω	1/4 W	5%
R863	315-0101-00			100 Ω	1/4 W	5%
R865	315-0101-00			100 Ω	1/4 W	5%
R867	315-0101-00			100 Ω	1/4 W	5%

Switches

Unwired or Wired

SW110A	} wired *262-0811-00	Rotary	INTERNAL TRIGGER SAMPLING MODE
SW110B			
SW110A			
SW110B			
SW168	wired *262-0810-00	Rotary	INTERNAL TRIGGER SAMPLING MODE CH A VOLTS/DIV
SW168	260-0859-00	Rotary	CH A VOLTS/DIV
SW290	260-0816-00	Slide	CH A INVERT NORM
SW293A,B ^a	*311-0659-00		CH A CAL
SW468	wired *262-0810-00	Rotary	CH B VOLTS/DIV
SW468	260-0859-00	Rotary	CH B VOLTS/DIV
SW590	260-0816-00	Slide	CH B INVERT NORM
SW593A,B ^a	*311-0659-00		CH B CAL
SW730A	} wired *262-0812-00	Rotary	VERTICAL MODE
SW730B			

^aFurnished as a unit with R293.

^aFurnished as a unit with R593.

Switches (cont)

Ckt. No.	Tektronix Part No.	Serial/Model No. Eff	No. Disc	Description
SW730A } SW730B }	260-0858-00			Rotary VERTICAL MODE

Transformers

T12	*120-0511-00			Toroid, 2 turns-12 turns
T72	*120-0491-00			Toroid, 7 turns bifilar
T113	276-0554-00			Core, Toroid Ferrite
T139	*120-0490-01			Toroid, 5 turns (twisted pair)
T140	*120-0512-00			Toroid, 5 turns
T235	*120-0492-00			Toroid, 3 windings
T439	*120-0490-01			Toroid, 5 turns (twisted pair)
T440	*120-0512-00			Toroid, 5 turns
T535	*120-0492-00			Toroid, 5 turns bifilar
T820	*120-0488-00			Power

Test Points

TP38	*214-0579-00			Pin, Test Point
TP58	*214-0579-00			Pin, Test Point
TP161	*214-0579-00			Pin, Test Point
TP196	*214-0579-00			Pin, Test Point
TP199	*214-0579-00			Pin, Test Point
TP229	*214-0579-00			Pin, Test Point
TP235	*214-0579-00			Pin, Test Point
TP279	*214-0579-00			Pin, Test Point
TP288	*214-0579-00			Pin, Test Point
TP313	*214-0579-00			Pin, Test Point
TP461	*214-0579-00			Pin, Test Point
TP496	*214-0579-00			Pin, Test Point
TP499	*214-0579-00			Pin, Test Point
TP529	*214-0579-00			Pin, Test Point
TP535	*214-0579-00			Pin, Test Point
TP579	*214-0579-00			Pin, Test Point
TP588	*214-0579-00			Pin, Test Point
TP613	*214-0579-00			Pin, Test Point
TP707	*214-0579-00			Pin, Test Point
TP714	*214-0579-00			Pin, Test Point
TP724	*214-0579-00			Pin, Test Point
TP817	*214-0579-00			Pin, Test Point
TP838	*214-0579-00			Pin, Test Point
TP839	*214-0579-00			Pin, Test Point

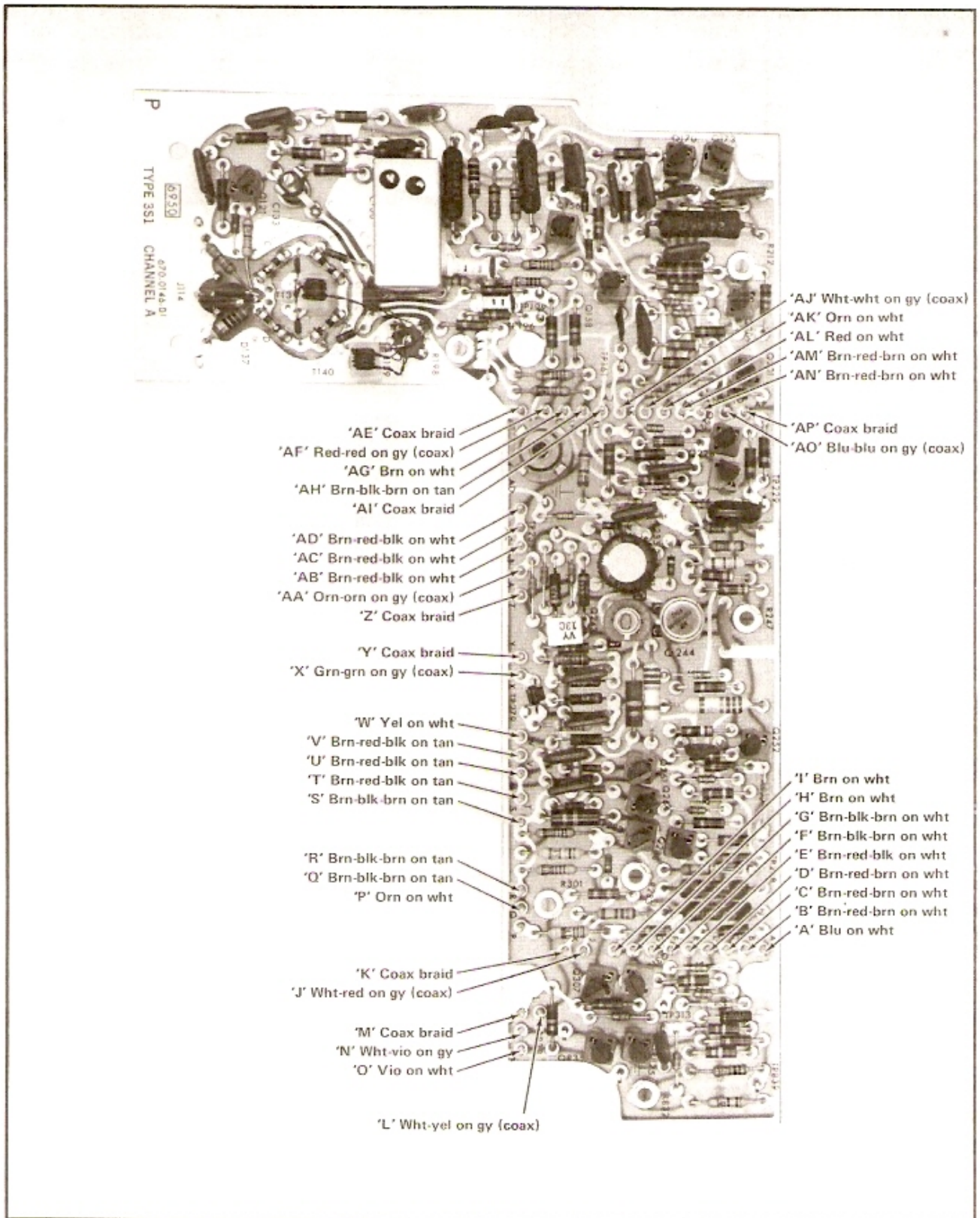

Fig. 6-11. Channel A circuit board assembly wiring color code.

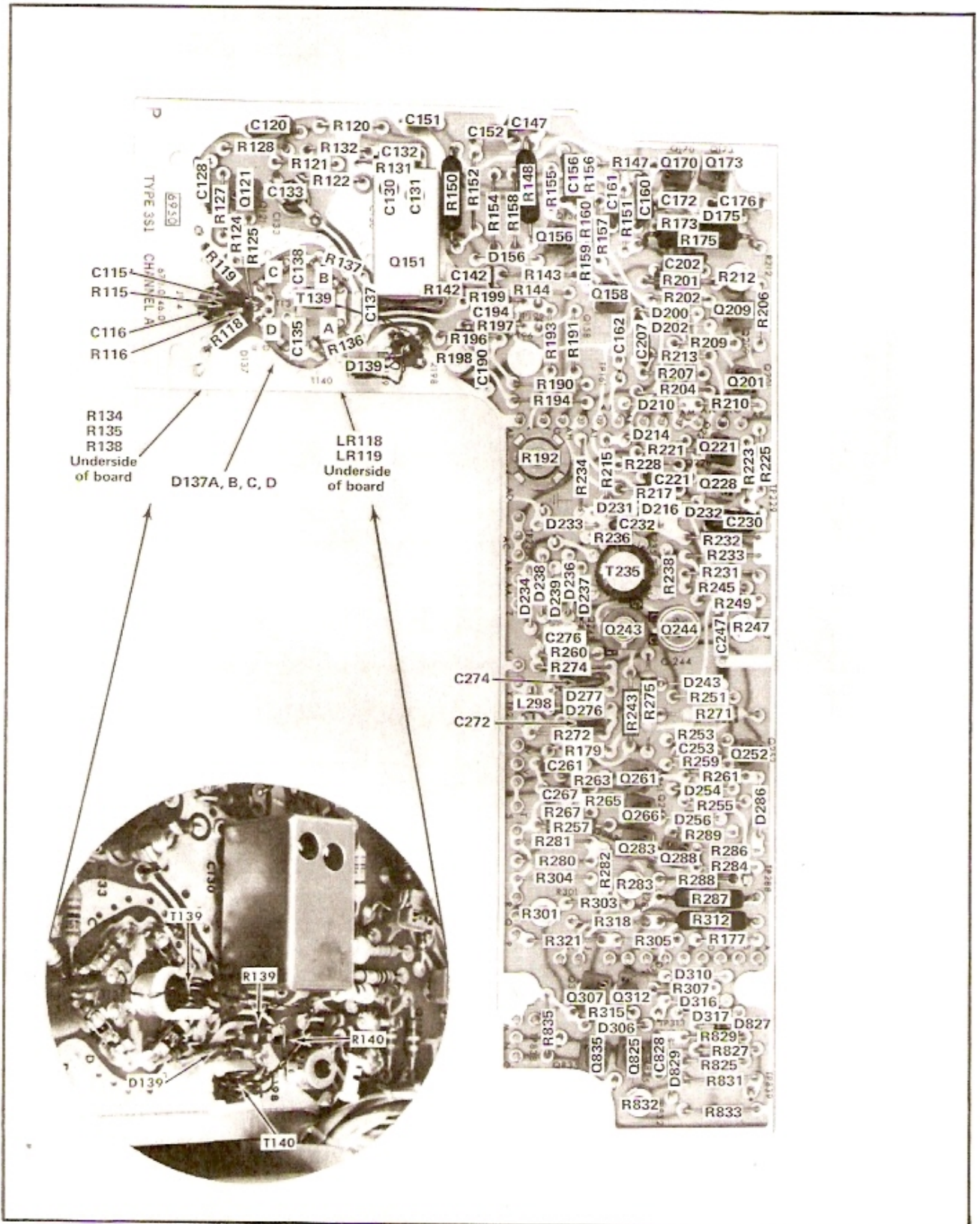

Fig. 6-12. Channel A circuit board assembly parts location.

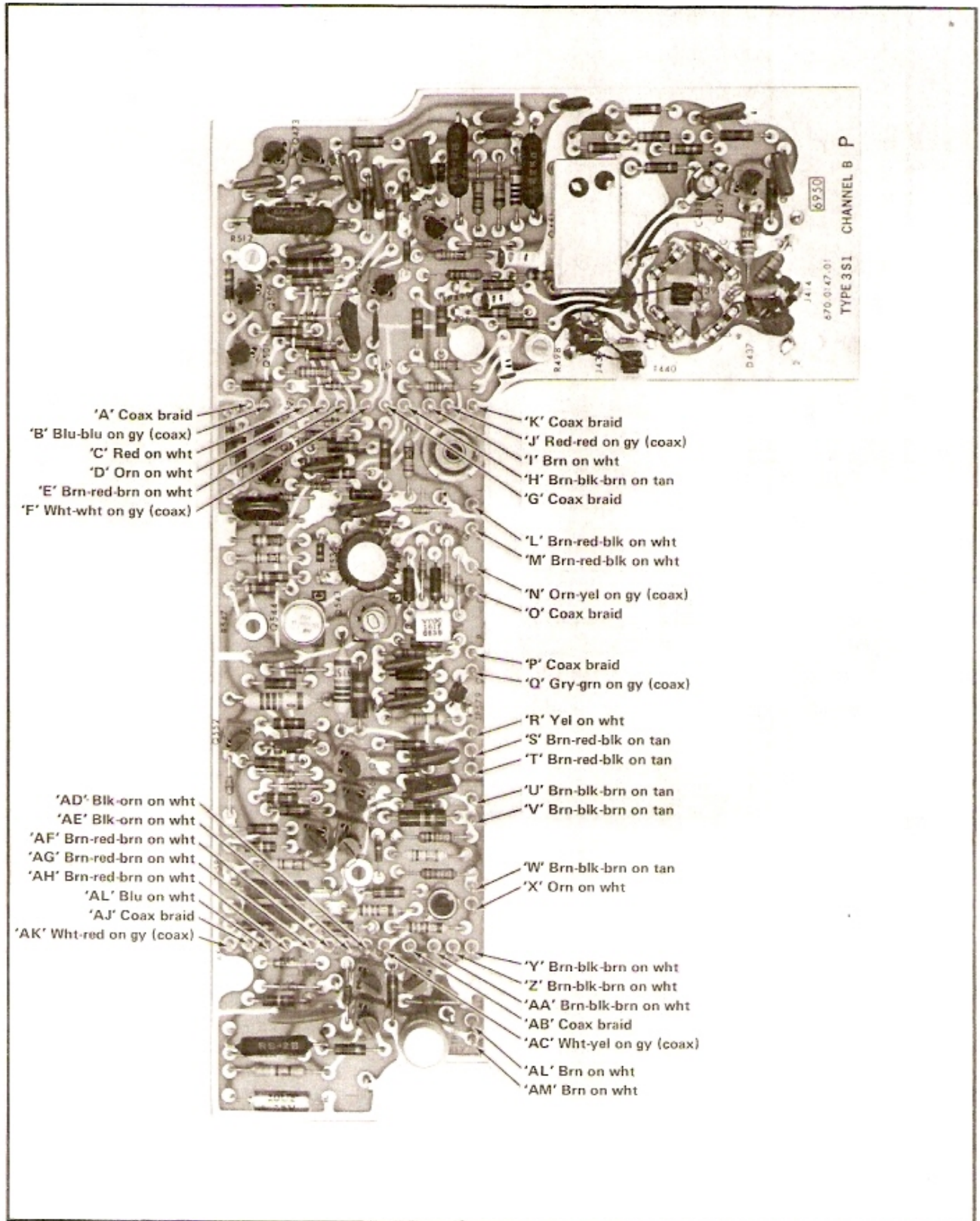

Fig. 6-13. Channel B circuit board assembly wiring color code.

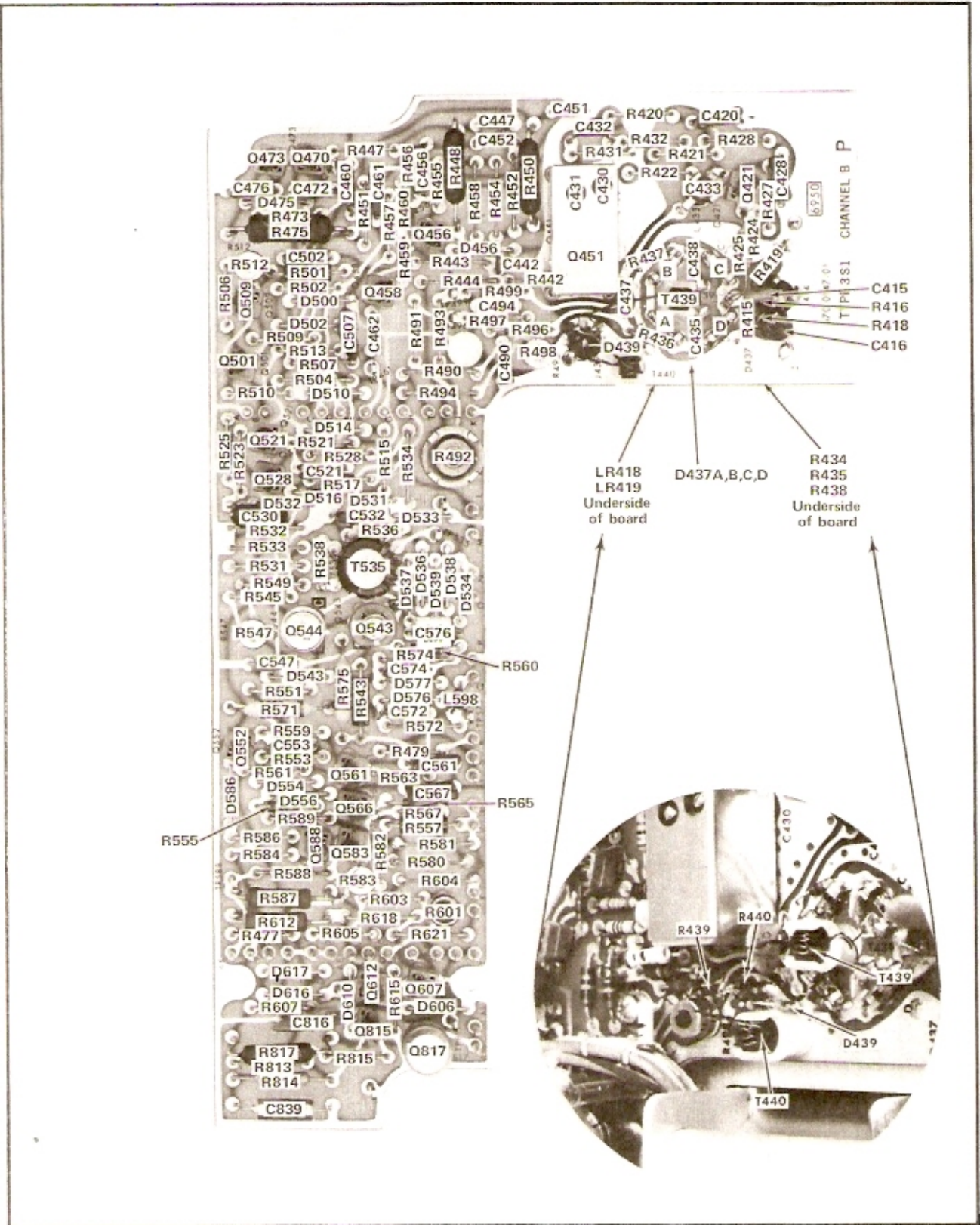
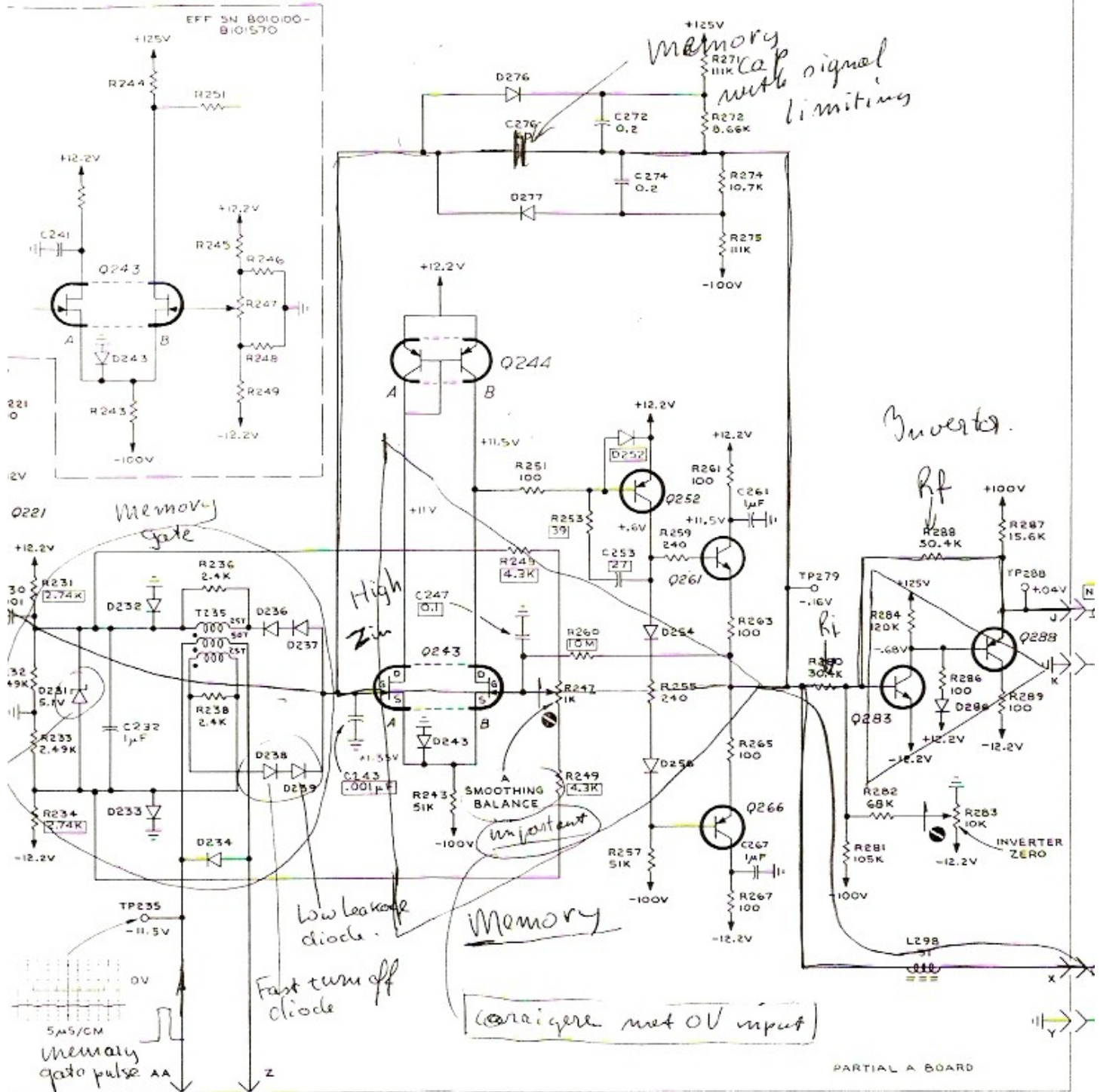

Fig. 6-14. Channel B circuit board assembly parts location.

MEMORY GATE | MEMORY AMPLIFIER | INVERTER



- REFERENCE DIAGRAMS
- ① GATE GENERATORS
 - ② CHAN A SAMPLER
 - ③ A & B CHANNEL AMPS

NOTE:
SEE PARTS LIST FOR SEMICONDUCTOR TYPES

SEE PARTS LIST FOR EARLIER VALUES AND SERIAL NUMBER RANGES OF PARTS MARKED WITH BLUE OUTLINE

FROM R64 MEMORY GATE DRIVER

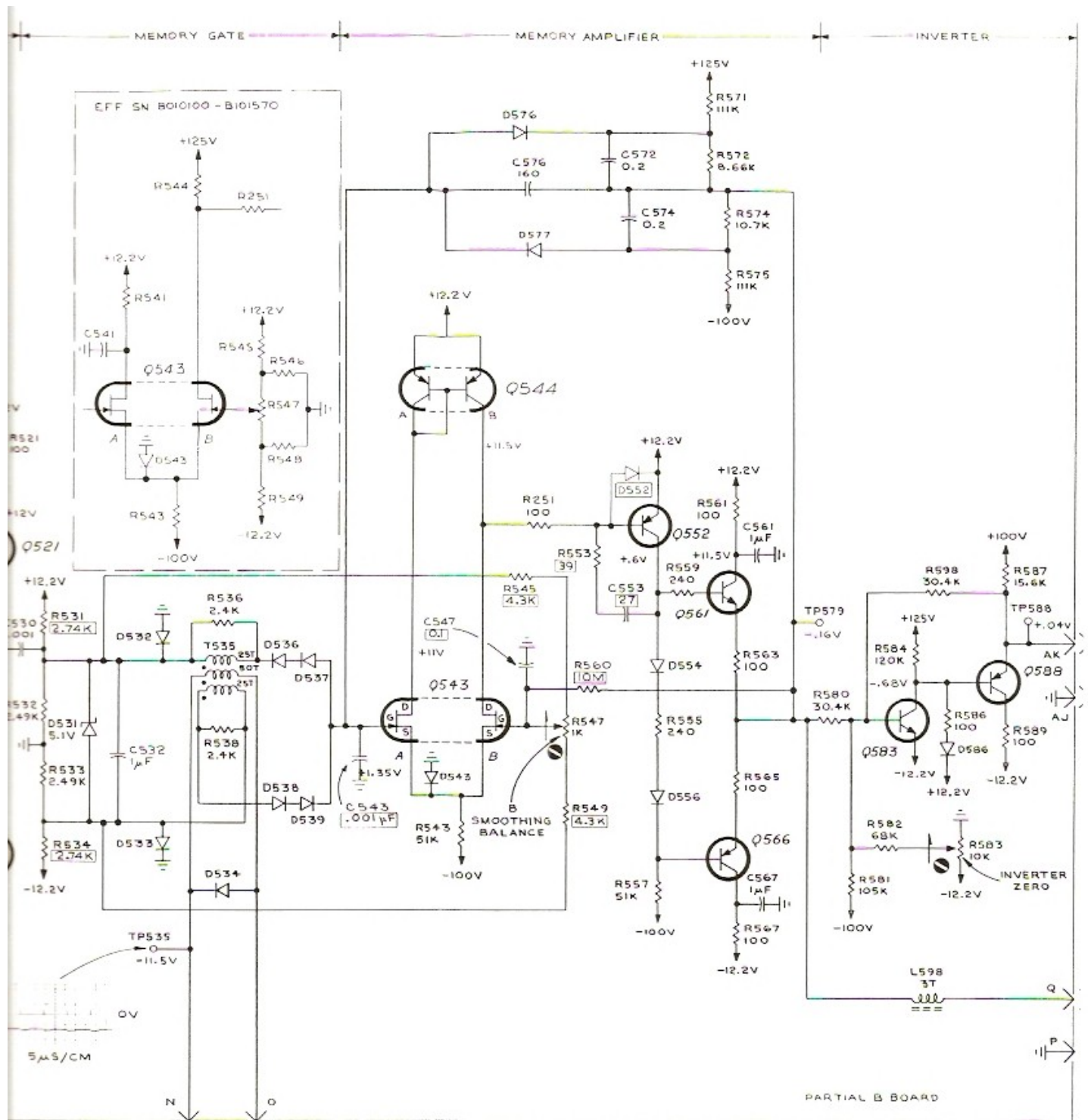

PARTIAL B BOARD

FROM R65
MEMORY GATE
DRIVER

SEE PARTS LIST FOR EARLIER
VALUES AND SERIAL NUMBER
RANGES OF PARTS MARKED
WITH BLUE OUTLINE

- REFERENCE DIAGRAMS
- ① GATE GENERATORS
 - ② CHAN B SAMPLER
 - ③ A & B CHANNEL AMPS

NOTE:
SEE PARTS LIST FOR
SEMICONDUCTOR TYPES

D

CHAN B ME

ELECTRICAL PARTS LIST AND SCHEMATIC CORRECTION

ADD:

C209	281-0512-00	27 pF	Cer	500 V
C509	281-0512-00	27 pF	Cer	500 V

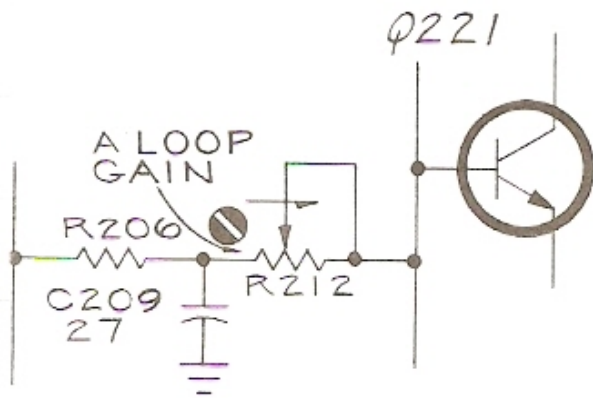

PARTIAL-
CHAN A MEMORY 4

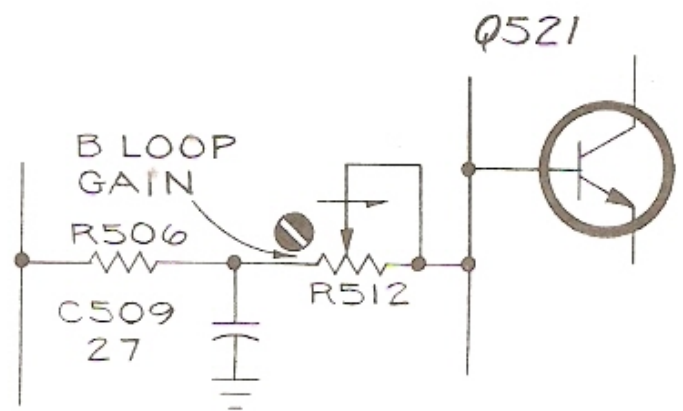

PARTIAL-
CHAN B MEMORY 5